

THR-3P-M5

General Description

Barlin Times also could design and produce fluid/pneumatic rotary joint with electrical part combination to meet the requirements of some special industries. So sometimes, we called this kind of slip ring for pneumatic slip ring/rotary joint, hydraulic slip ring, pneumatic rotary union, steam rotary joint, air precision slip ring, rotary unions for air and so on. Actually, the performance of this kind of rotary joint can be as same as slip ring part, its also would be used in any electromechanical system that requires unrestrained, continuous rotation during transferring power or signals from a stationary to rating structure ., which could simplify equipment design and optimize system performance.

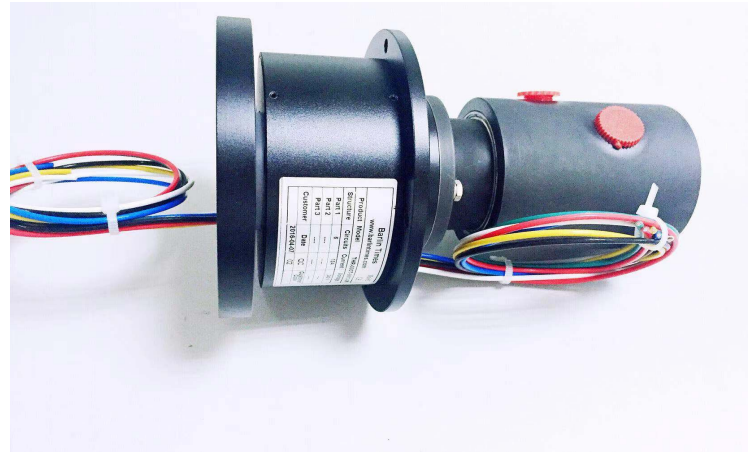

Features:

1. Compact design
2. Liquid/ pneumatic with electrical slip ring combination
3. Transfer power and various signal for electrical part
4. Reliable after sales service and maintenance free
5. High work speed and big pressure as per special demand

Option:

1. Liquid & pneumatic with electrical slip ring is available
2. Liquid or pneumatic channels could be up to 20, electrical circuits can be from 1-48
3. Customize liquid or pneumatic tube size to pass different media as per requirement of customer
4. Through bore or solid hole is optional
5. Work speed & work voltage
6. Cable length & connector
7. Installation method

Application

1. Rotary table
2. Polishing machine
3. Cleaning equipment
4. Automation equipment
5. Packing machine

Specification:

Specification	
Gas Channel	3
Circuits & Current	/
Dimension	45*69(OD*L)
Work Pressure	0-1Mpa
Tube Size	M5
Work Speed	0-100rpm
Work Temperature	-20°C + 80°C
Work Humidity	60%RH
Voltage Rating	380VAC
Insulation Resistance	500MΩ@500VDC
Contact Materials	Silver to silver
Lead Wire Size	/
Lead Wire Length	/
Housing Materials	Carbon Steel
Protection	IP54 or higher

Drawing:

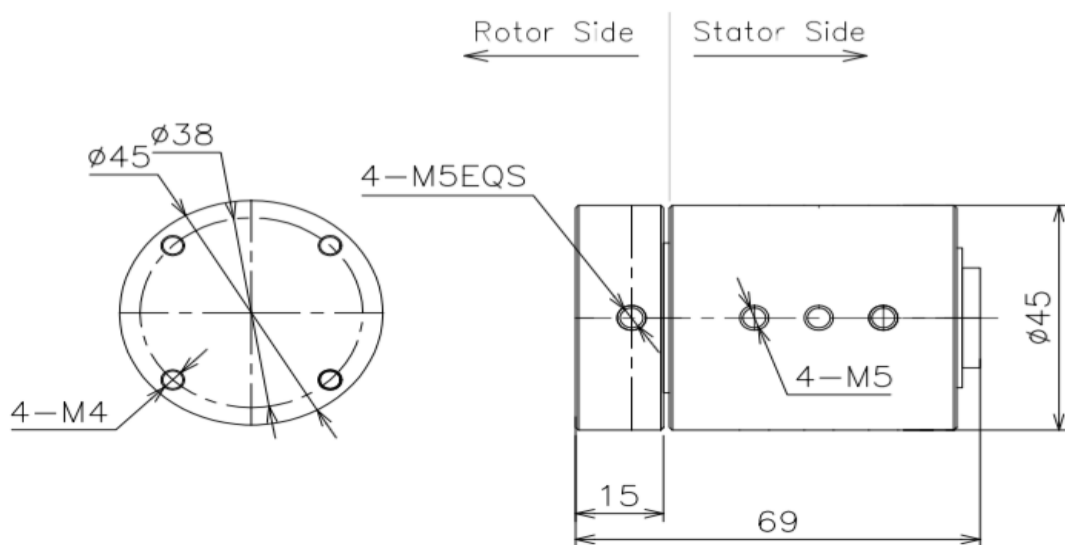

If you have specific customized requirement, please feel free to consult us so that our sales engineer could recommend the most suitable product to you for your reference.